

**PLEASE CHECK WWW.MOLEX.COM FOR LATEST PART INFORMATION**

**Part Number:** [0015477608](#)  
**Status:** **Active**  
**Description:** 2.54mm (.100") Pitch C-Grid® Header, Through Hole, Dual Row, Vertical, High Temperature, Shrouded, with Peg, 8 Circuits, 0.38µm (15µ") Gold (Au) Selective Plating, Tin (Sn) PC Tail Plating

**Documents:**

[3D Model](#) [Product Specification PS-70567 \(PDF\)](#)  
[Drawing \(PDF\)](#) [RoHS Certificate of Compliance \(PDF\)](#)

**Agency Certification**

CSA LR19980  
 UL E29179

**General**

Product Family PCB Headers  
 Series [70568](#)  
 Application Wire-to-Board  
 Product Name C-Grid®

**Physical**

Breakaway No  
 Circuits (Loaded) 8  
 Color - Resin Black  
 First Mate / Last Break No  
 Flammability 94V-0  
 Glow-Wire Compliant No  
 Guide to Mating Part No  
 Keying to Mating Part None  
 Lock to Mating Part Yes  
 Material - Metal Brass, Phosphor Bronze  
 Material - Plating Mating Gold  
 Material - Resin High Temperature Thermoplastic  
 Number of Rows 2  
 Orientation Vertical  
 PC Tail Length (in) 0.130 In  
 PC Tail Length (mm) 3.30 mm  
 PCB Locator No  
 PCB Retention Yes  
 PCB Thickness Recommended (in) 0.093 In  
 PCB Thickness Recommended (mm) 2.40 mm  
 Packaging Type Tube  
 Pitch - Mating Interface (in) 0.100 In  
 Pitch - Mating Interface (mm) 2.54 mm  
 Pitch - Term. Interface (in) 0.100 In  
 Pitch - Term. Interface (mm) 2.54 mm  
 Plating min: Mating (µin) 15  
 Plating min: Mating (µm) 0.38  
 Polarized to Mating Part Yes  
 Polarized to PCB Yes  
 Shrouded Fully  
 Stackable No  
 Surface Mount Compatible (SMC) No  
 Temperature Range - Operating -55°C to +105°C  
 Termination Interface: Style Through Hole

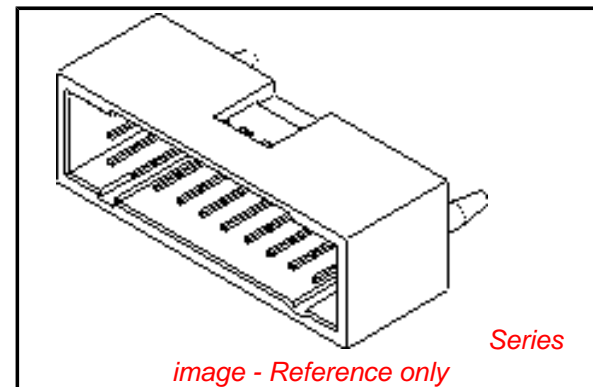

**EU RoHS**

**ELV and RoHS Compliant**  
**REACH SVHC Contains SVHC: No**  
**Halogen-Free Status**

**China RoHS**



**Not Reviewed**

**Need more information on product environmental compliance?**

Email [productcompliance@molex.com](mailto:productcompliance@molex.com)  
 For a multiple part number RoHS Certificate of Compliance, [click here](#)

Please visit the [Contact Us](#) section for any non-product compliance questions.

**Search Parts in this Series**

[70568Series](#)

**Electrical**

Current - Maximum per Contact 2.5A  
Voltage - Maximum 250V

**Solder Process Data**

Duration at Max. Process Temperature (seconds) 5  
Lead-free Process Capability SMC & Wave Capable (TH only)  
Max. Cycles at Max. Process Temperature 1  
Process Temperature max. C 245

**Material Info**

Old Part Number A-70568-0036

**Reference - Drawing Numbers**

Product Specification PS-70567  
Sales Drawing SDA-70568-\*\*\*\*

This document was generated on 03/31/2010

**PLEASE CHECK [WWW.MOLEX.COM](http://WWW.MOLEX.COM) FOR LATEST PART INFORMATION**

STAND OFFS CAN BE EITHER ROUND OR SQUARE.

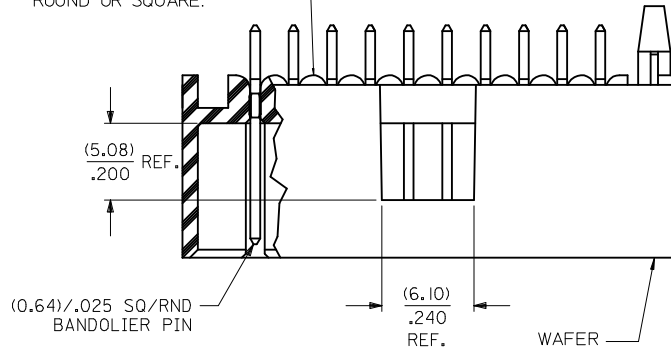

NOTES:

1. MATERIAL: WAFER - GLASS FILLED LIQUID CRYSTAL POLYMER, UL 94V-0, COLOR: BLACK, PIN: COPPER ALLOY.
2. PLATING: TIN  
 TIN(Sn) ALLOY OVER ENTIRE PIN: THICKNESS = (3.81 MICROMETER)/ 150 MICROINCH MINIMUM;  
 NICKEL (Ni) UNDERPLATE OVER ENTIRE PIN.  
 15 GOLD SELECTIVE GOLD (Au) IN THE CONTACT AREA: THICKNESS = (0.38 MICROMETER)/ 15 MICROINCH MINIMUM;  
 SELECTIVE TIN (Sn) ALLOY IN THE PC TAIL AREA: THICKNESS = (1.91 MICROMETER)/ 75 MICROINCH MINIMUM;  
 NICKEL (Ni) UNDERPLATE OVER ENTIRE PIN.  
 30 GOLD SELECTIVE GOLD (Au) IN THE CONTACT AREA: THICKNESS = (0.76 MICROMETER)/ 30 MICROINCH MINIMUM;  
 SELECTIVE TIN (Sn) ALLOY IN THE PC TAIL AREA: THICKNESS = (1.91 MICROMETER)/ 75 MICROINCH MINIMUM;  
 NICKEL (Ni) UNDERPLATE OVER ENTIRE PIN.  
 \* THE PRIMARY SHIPPING CARTON WILL BE LABELED "COMPLIANT TO RoHS DIRECTIVE 2002/95/EC AND ELV ANNEX II OF DIRECTIVE 2000/53/EC". CARTONS WITHOUT THIS LABEL MAY CONTAIN PRODUCT WITH LEAD.
3. PRODUCT SPECIFICATION: PS-70567.
4. PACKAGING: SEE CHARTS
5. PIN PUSHOUT FORCE: 4 LBS. MIN. IN DIRECTION INDICATED.
6. FOR ILLUSTRATION PURPOSES, 20 (DUAL 10) CIRCUIT SIZE IS SHOWN.
7. PINS MUST MEET SOLDERABILITY SPEC. SMS-152.  
 EXCEPT VOIDS ARE PERMISSIBLE AT BANDOLIER PIN FAYING SURFACE. (APPROX. (0.64)/.025 LNG X (0.15)/.006 WD. REF.) - 2 LOCATIONS
8. NO FEATURES WHICH RISE ABOVE THE PCB SURFACE ALLOWED IN THIS AREA.
9. THIS PART CONFORMS TO CLASS B REQUIREMENTS OF COSMETIC SPEC PS-45499-002.

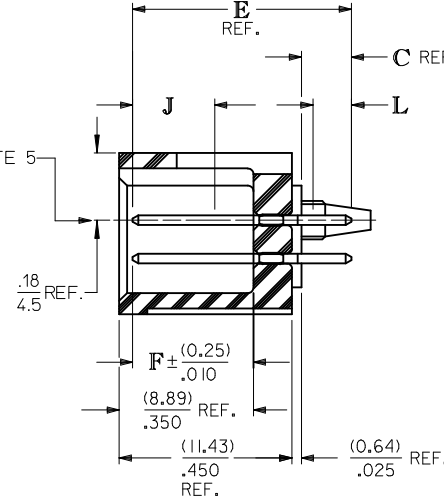
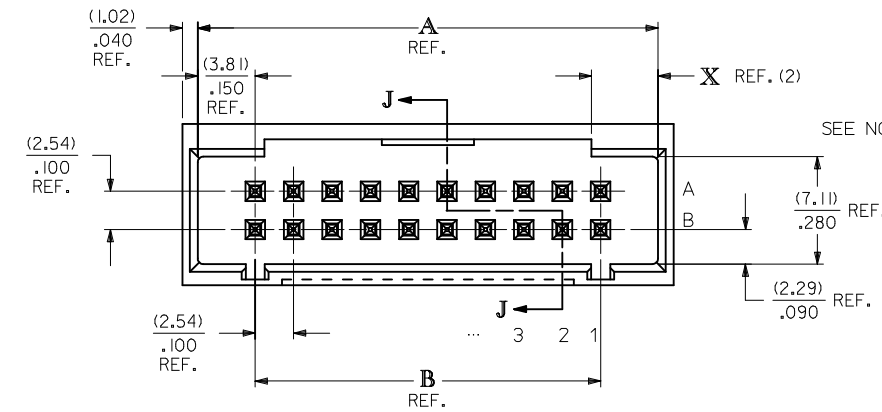

CKT. SIZE	DIM. A REF.		DIM. B REF.		DIM. X REF.	
	(MM)	INCH	(MM)	INCH	(MM)	INCH
6	(12.70)	.500	(5.08)	.200	(3.18)	.125
8	(15.24)	.600	(7.62)	.300	(4.42)	.174
10	(17.78)	.700	(10.16)	.400	(4.42)	.174
12	(20.32)	.800	(12.70)	.500	(4.42)	.174
14	(22.86)	.900	(15.24)	.600	(4.42)	.174
16	(25.40)	1.000	(17.78)	.700	(4.42)	.174
18	(27.94)	1.100	(20.32)	.800	(4.42)	.174
20	(30.48)	1.200	(22.86)	.900	(4.42)	.174
22	(33.02)	1.300	(25.40)	1.000	(4.42)	.174
24	(35.56)	1.400	(27.94)	1.100	(4.42)	.174
26	(38.10)	1.500	(30.48)	1.200	(4.42)	.174
28	(40.64)	1.600	(33.02)	1.300	(4.42)	.174
30	(43.18)	1.700	(35.56)	1.400	(4.42)	.174
32	(45.72)	1.800	(38.10)	1.500	(4.42)	.174
34	(48.26)	1.900	(40.64)	1.600	(4.42)	.174
36	(50.80)	2.000	(43.18)	1.700	(4.42)	.174
40	(55.88)	2.200	(48.26)	1.900	(4.42)	.174
42	(58.42)	2.300	(50.80)	2.000	(4.42)	.174
44	(60.96)	2.400	(53.34)	2.100	(4.42)	.174
46	(63.50)	2.500	(55.88)	2.200	(4.42)	.174
48	(66.04)	2.600	(58.42)	2.300	(4.42)	.174
50	(68.58)	2.700	(60.96)	2.400	(4.42)	.174
52	(71.12)	2.800	(63.50)	2.500	(4.42)	.174
54	(73.66)	2.900	(66.04)	2.600	(4.42)	.174
56	(76.20)	3.000	(68.58)	2.700	(4.42)	.174
58	(78.74)	3.100	(71.12)	2.800	(4.42)	.174
60	(81.28)	3.200	(73.66)	2.900	(4.42)	.174
62	(83.82)	3.300	(76.20)	3.000	(4.42)	.174
64	(86.36)	3.400	(78.74)	3.100	(4.42)	.174
66	(88.90)	3.500	(81.28)	3.200	(4.42)	.174
68	(91.44)	3.600	(83.82)	3.300	(4.42)	.174
70	(93.98)	3.700	(86.36)	3.400	(4.42)	.174
72	(96.52)	3.800	(88.90)	3.500	(4.42)	.174

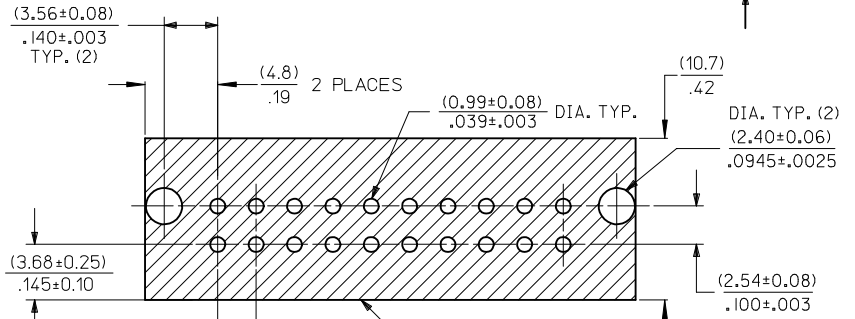
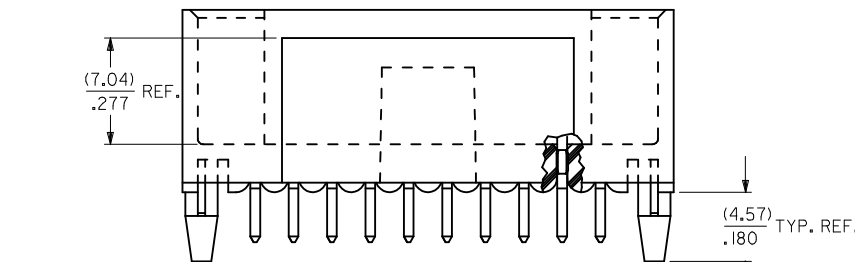



**RECOMMENDED P.C. BOARD HOLE LAYOUT**

<b>MODIFIED NOTES</b> EC NO: UCP2009-0336 DRAWN: JLOSTER/ER 2008/09/23 CHKD: JBEL 2008/09/24 APPR: FSMITH 2008/09/25	QUALITY SYMBOLS ▽=0 ▽=0	GENERAL TOLERANCES (UNLESS SPECIFIED) mm INCH 4 PLACES ± --- ± --- 3 PLACES ± --- ± .005 2 PLACES ± 0.13 ± .01 1 PLACE ± 0.25 ± --- ANGULAR ± 1/2°	DIMENSION STYLE MM/IN DRAWN BY DATE SMR 1993/11/10 CHECKED BY DATE SMR 1993/11/10 APPROVED BY DATE	SCALE 4:1 DESIGN UNITS INCH THIRD ANGLE PROJECTION
		DRAFT WHERE APPLICABLE MUST REMAIN WITHIN DIMENSIONS	MATERIAL NO. SEE TABLE SIZE C	SHEET NO. 1 OF 2
		SALES ASSY - DUAL ROW SHROUDED WAFER/HI TEMP .25SQ/RND PINS .100 GRID		
		MOLEX INCORPORATED SDA-70568-****		

	13	12	11	10	9	8	7	6	5	4	3	2	1	
J	ENGINEERING NUMBER A-70568	RELEASE FOR MANUFACTURE			C REF.	E REF.	F ±(0.25) .010			CONNECTOR END PLATING		P.C. BOARD END PLATING		SEE PACK INFORMA. DRAWING PK-70873
										TYPE	J MINIMUM LENGTH	TYPE	L MINIMUM LENGTH	
	-0001/0034	R.F.M.			(3.30) .130	(14.48) .570	(8.00) .315			TIN	OVER- ALL	TIN	OVER- ALL	-0018
	-0035/-0068	R.F.M.			(3.30) .130	(14.48) .570	(8.00) .315			15 GOLD	(5.08) .200	TIN	(3.56) .140	-0018
I	-0069/-0102	R.F.M.			(3.30) .130	(14.48) .570	(8.00) .315			30 GOLD	(5.08) .200	TIN	(3.56) .140	-0018
	-0103/-0136													
	-0137/-0170													
H	-0171/-0204													
	-0205/-0238													

CKTS	EDP NUMBER	ENG NUMBER	EDP NUMBER	ENG NUMBER	EDP NUMBER	ENG NUMBER	EDP NUMBER	ENG NUMBER	EDP NUMBER	ENG NUMBER	EDP NUMBER	ENG NUMBER	EDP NUMBER	ENG NUMBER	CKTS	
G	06	15-47-7506	A-70568-0001	15-47-7606	A-70568-0035	15-47-7706	A-70568-0069		A-70568-0103		A-70568-0137		A-70568-0171		A-70568-0205	06
	08	15-47-7508	A-70568-0002	15-47-7608	A-70568-0036	15-47-7708	A-70568-0070		A-70568-0104		A-70568-0138		A-70568-0172		A-70568-0206	08
	10	15-47-7510	A-70568-0003	15-47-7610	A-70568-0037	15-47-7710	A-70568-0071		A-70568-0105		A-70568-0139		A-70568-0173		A-70568-0207	10
	12	15-47-7512	A-70568-0004	15-47-7612	A-70568-0038	15-47-7712	A-70568-0072		A-70568-0106		A-70568-0140		A-70568-0174		A-70568-0208	12
	14	15-47-7514	A-70568-0005	15-47-7614	A-70568-0039	15-47-7714	A-70568-0073		A-70568-0107		A-70568-0141		A-70568-0175		A-70568-0209	14
	16	15-47-7516	A-70568-0006	15-47-7616	A-70568-0040	15-47-7716	A-70568-0074		A-70568-0108		A-70568-0142		A-70568-0176		A-70568-0210	16
	18	15-47-7518	A-70568-0007	15-47-7618	A-70568-0041	15-47-7718	A-70568-0075		A-70568-0109		A-70568-0143		A-70568-0177		A-70568-0211	18
	20	15-47-7520	A-70568-0008	15-47-7620	A-70568-0042	15-47-7720	A-70568-0076		A-70568-0110		A-70568-0144		A-70568-0178		A-70568-0212	20
F	22	15-47-7522	A-70568-0009	15-47-7622	A-70568-0043	15-47-7722	A-70568-0077		A-70568-0111		A-70568-0145		A-70568-0179		A-70568-0213	22
	24	15-47-7524	A-70568-0010	15-47-7624	A-70568-0044	15-47-7724	A-70568-0078		A-70568-0112		A-70568-0146		A-70568-0180		A-70568-0214	24
	26	15-47-7526	A-70568-0011	15-47-7626	A-70568-0045	15-47-7726	A-70568-0079		A-70568-0113		A-70568-0147		A-70568-0181		A-70568-0215	26
	28	15-47-7528	A-70568-0012	15-47-7628	A-70568-0046	15-47-7728	A-70568-0080		A-70568-0114		A-70568-0148		A-70568-0182		A-70568-0216	28
	30	15-47-7530	A-70568-0013	15-47-7630	A-70568-0047	15-47-7730	A-70568-0081		A-70568-0115		A-70568-0149		A-70568-0183		A-70568-0217	30
	32	15-47-7532	A-70568-0014	15-47-7632	A-70568-0048	15-47-7732	A-70568-0082		A-70568-0116		A-70568-0150		A-70568-0184		A-70568-0218	32
	34	15-47-7534	A-70568-0015	15-47-7634	A-70568-0049	15-47-7734	A-70568-0083		A-70568-0117		A-70568-0151		A-70568-0185		A-70568-0219	34
E	36	15-47-7536	A-70568-0016	15-47-7636	A-70568-0050	15-47-7736	A-70568-0084		A-70568-0118		A-70568-0152		A-70568-0186		A-70568-0220	36
	38	15-47-7538	A-70568-0017	15-47-7638	A-70568-0051	15-47-7738	A-70568-0085		A-70568-0119		A-70568-0153		A-70568-0187		A-70568-0221	38
	40	15-47-7540	A-70568-0018	15-47-7640	A-70568-0052	15-47-7740	A-70568-0086		A-70568-0120		A-70568-0154		A-70568-0188		A-70568-0222	40
	42	15-47-7542	A-70568-0019	15-47-7642	A-70568-0053	15-47-7742	A-70568-0087		A-70568-0121		A-70568-0155		A-70568-0189		A-70568-0223	42
	44	15-47-7544	A-70568-0020	15-47-7644	A-70568-0054	15-47-7744	A-70568-0088		A-70568-0122		A-70568-0156		A-70568-0190		A-70568-0224	44
	46	15-47-7546	A-70568-0021	15-47-7646	A-70568-0055	15-47-7746	A-70568-0089		A-70568-0123		A-70568-0157		A-70568-0191		A-70568-0225	46
	48	15-47-7548	A-70568-0022	15-47-7648	A-70568-0056	15-47-7748	A-70568-0090		A-70568-0124		A-70568-0158		A-70568-0192		A-70568-0226	48
	50	15-47-7550	A-70568-0023	15-47-7650	A-70568-0057	15-47-7750	A-70568-0091		A-70568-0125		A-70568-0159		A-70568-0193		A-70568-0227	50
D	52	15-47-7552	A-70568-0024	15-47-7652	A-70568-0058	15-47-7752	A-70568-0092		A-70568-0126		A-70568-0160		A-70568-0194		A-70568-0228	52
	54	15-47-7554	A-70568-0025	15-47-7654	A-70568-0059	15-47-7754	A-70568-0093		A-70568-0127		A-70568-0161		A-70568-0195		A-70568-0229	54
	56	15-47-7556	A-70568-0026	15-47-7656	A-70568-0060	15-47-7756	A-70568-0094		A-70568-0128		A-70568-0162		A-70568-0196		A-70568-0230	56
	58	15-47-7558	A-70568-0027	15-47-7658	A-70568-0061	15-47-7758	A-70568-0095		A-70568-0129		A-70568-0163		A-70568-0197		A-70568-0231	58
	60	15-47-7560	A-70568-0028	15-47-7660	A-70568-0062	15-47-7760	A-70568-0096		A-70568-0130		A-70568-0164		A-70568-0198		A-70568-0232	60
	62	15-47-7562	A-70568-0029	15-47-7662	A-70568-0063	15-47-7762	A-70568-0097		A-70568-0131		A-70568-0165		A-70568-0199		A-70568-0233	62
	64	15-47-7564	A-70568-0030	15-47-7664	A-70568-0064	15-47-7764	A-70568-0098		A-70568-0132		A-70568-0166		A-70568-0200		A-70568-0234	64
	66	15-47-7566	A-70568-0031	15-47-7666	A-70568-0065	15-47-7766	A-70568-0099		A-70568-0133		A-70568-0167		A-70568-0201		A-70568-0235	66
C	68	15-47-7568	A-70568-0032	15-47-7668	A-70568-0066	15-47-7768	A-70568-0100		A-70568-0134		A-70568-0168		A-70568-0202		A-70568-0236	68
	70	15-47-7570	A-70568-0033	15-47-7670	A-70568-0067	15-47-7770	A-70568-0101		A-70568-0135		A-70568-0169		A-70568-0203		A-70568-0237	70
	72	15-47-7572	A-70568-0034	15-47-7672	A-70568-0068	15-47-7772	A-70568-0102		A-70568-0136		A-70568-0170		A-70568-0204		A-70568-0238	72

MODIFY PLATE EC NO: UCP2006-2806 2006/05/31 DRAWN:MS/BARRA 2006/06/06 CHKD:DMORGAN 2006/06/06 APPR:SMILLER 2006/06/07	QUALITY SYMBOLS  = 0  + 0	GENERAL TOLERANCES (UNLESS SPECIFIED)		DIMENSION STYLE MM/IN		SCALE ---	DESIGN UNITS INCH	THIRD ANGLE PROJECTION			
		4 PLACES ± --- ± ---	3 PLACES ± --- ± .005	2 PLACES ± 0.13 ± .01	1 PLACE ± 0.25 ± ---	DRAWN BY SMR	DATE 1993/11/10	TITLE SALES ASSY-DUAL ROW SHROUDED WAFER/HIGH TEMP .025SQ/RND PIN .100 GRID			
		ANGULAR ±1/2°				CHECKED BY SMR	DATE 1993/11/10	MATERIAL NO. SDA-70568-****			
		DRAFT WHERE APPLICABLE MUST REMAIN WITHIN DIMENSIONS				APPROVED BY	DATE	SHEET NO. 2 OF 2			
						SEE TABLE		THIS DRAWING CONTAINS INFORMATION THAT IS PROPRIETARY TO MOLEX INCORPORATED AND SHOULD NOT BE USED WITHOUT WRITTEN PERMISSION			